

ETT 1234

Build-in Touch Terminal

Instruction Manual

Publisher: SIGMATEK GmbH & Co KG
A-5112 Lamprechtshausen
Tel.: +43/6274/4321
Fax: +43/6274/4321-18
Email: office@sigmatek.at
WWW.SIGMATEK-AUTOMATION.COM

Copyright © 2019
SIGMATEK GmbH & Co KG

Translation from German

All rights reserved. No part of this work may be reproduced, edited using an electronic system, duplicated or distributed in any form (print, photocopy, microfilm or in any other process) without express permission.

We reserve the right to make changes in the content without notice. SIGMATEK GmbH & Co KG is not responsible for technical or printing errors in this handbook and assumes no responsibility for damages that occur through its use.

Build-in Touch Terminal

ETT 1234

The ETT 1234 is an intelligent panel for visualizing, operating and monitoring automated processes.

A capacitive touch screen serves as the input medium for process data and parameters. The output is shown on a 12.1" TFT color display.

The available interfaces can be used to exchange process data or configure the multi-touch terminal. A microSD card serves as the storage medium for the operating system, application and application data.



Contents

1	Introduction	5
1.1	Target Group/Purpose of this Manual	5
1.2	Important Reference Documentation	5
1.3	Contents of Delivery	5
2	Basic Safety Guidelines	6
2.1	Symbols Used	6
2.2	Disclaimer	7
2.3	General Safety Guidelines	8
2.4	Guidelines.....	10
2.4.1	EU Conformity Declaration	10
3	Technical Data	11
3.1	Performance Data	11
3.2	Electrical Requirements.....	12
3.3	12.1" WXGA Display	13
3.4	Control Unit	13
3.5	Minimum Distance between Operating Elements for Multi-touch Applications	14
3.6	Environmental Conditions	15
3.7	Miscellaneous	15
4	Mechanical Dimensions	16
5	Interfaces.....	17

5.1	Bottom Connections.....	17
5.1.1	X1: Supply (4-pin Phoenix RM 3.5).....	17
5.1.2	X2: Ethernet 2 10/100/1000 (RJ45)	17
5.1.3	X3: Ethernet 1 10/100 (RJ45)	17
5.1.4	X4: microSD Card	18
5.1.5	X5: USB 2.0 (Type A)	19
5.3	Side Connection.....	20
5.3.1	X6: USB 2.0 (Type Mini B).....	21
5.4	Applicable Connectors.....	21
6	Cooling.....	22
7	Mounting Instructions.....	22
7.1	Restricted Space Around Rear Trimming	23
7.2	Required Cutout for Mounting the Terminal	24
7.3	Mounting Position.....	24
8	Wiring Guidelines.....	25
8.1	Protective Earth Connection	25
8.2	Shielding.....	25
8.3	ESD Protection.....	26
8.4	USB Interface Connections	26
9	Status LEDs	27
10	Display „Burn-In“ Effect	28

11	Cleaning the Touch Screen	29
12	Buffer Battery	30
12.1	Exchanging the Battery	31
12.1.1	Without Supply	31
12.1.2	With Active Supply.....	33
13	Maintenance	34
13.1	Maintenance	34
13.1.1	Calibrating the Touch Screen	34
13.2	Repair	34
13.3	Position Series Label Sub Device	35
14	Process Diagram	36
15	Status and Error Messages	37
16	Modularity	45
16.1	Mounting	45
16.2	Disassembly	46
17	Accessories	47
17.1	Buffer Battery	47
18	Transport/Storage	47
19	Disposal	47

1 Introduction

1.1 Target Group/Purpose of this Manual

This manual contains all information required for operating the ETT 1234.

This manual is intended for:

- Project planners
- Technicians
- Configurators/commissioning engineers
- Machine operators
- Maintenance/test technicians

General knowledge of automation technology is required.

Further help and training information, as well as the appropriate accessories can be found on our website www.sigmatek-automation.com.

Our support team is also happily available to answer your questions. Information regarding our support hotline, as well as business hours can be found on the previously mentioned website.

1.2 Important Reference Documentation

- HW IP Address Settings

This document can be downloaded from our website.

1.3 Contents of Delivery

ETT 1234

8x angle bracket

1x 4-pin Phoenix connector plug

Additional documents may be included with delivery.

2 Basic Safety Guidelines

2.1 Symbols Used

The following symbols are used in the operator documentation for warning and danger messages, as well as informational notes:

DANGER



Identifies an immediate danger with high risk, which **will** lead to immediate death or serious injury if not avoided.

Identifie un danger immédiat avec un risque élevé, entraînant le décès immédiat ou des blessures graves s'il n'est pas évité

WARNING



Identifies a possible danger with a mid-level risk, which **can** lead to death or (serious) injury if not avoided.

Indique un danger possible d'un risque moyen de décès ou de (graves) blessures si les consignes de sécurité ne sont pas respectées.

CAUTION



Identifies a low risk danger, which can lead to injury or property damage if not avoided.

Indique un danger avec un niveau de risque faible des blessures légères ou des dommages matériels si les consignes de sécurité ne sont pas respectées



Provides user tips, informs of special features and identifies especially important information in the text.

Fournit des conseils d'utilisation, informe sur les fonctions particulières et souligne les informations particulièrement importantes dans le texte.



Danger for ESD-sensitive components.

Les signes de danger pour les composants sensibles aux décharges électrostatiques.

2.2 Disclaimer



The contents of this document were prepared with the greatest care. However, deviations cannot be ruled out. This document is regularly checked and required corrections are included in the subsequent versions. The machine manufacturer is responsible for the proper assembly, as well as device configuration. The machine operator is responsible for safe handling, as well as proper operation.

The current document can be found on our website. If necessary, contact our support.

Subject to technical changes, which improve the performance of the devices. The following documentation is purely a product description. It does not guarantee properties under the warranty.

Please thoroughly read the corresponding data sheets, operating instructions and this system handbook before handling a product.

SIGMATEK GmbH & Co KG is not liable for damages caused through non-compliance with these instructions or applicable regulations.

The general and special safety instructions described in the following sections, as well as technical regulations, must therefore be observed.

2.3 General Safety Guidelines



According to EU Guidelines, the operating instructions are a component of a product.

This manual must therefore be accessible in the vicinity of the machine since it contains important instructions.

This technical documentation should be included in the sale, rental or transfer of the product, or its online availability indicated.

Maintain this manual in readable condition and keep it accessible for reference.

Regarding the requirements for Safety and health connected to the use of machines, the manufacturer must perform a risk assessment in accordance with machine guidelines 2006/42/EG before introducing a machine to the market.

Before commissioning this product, check that conformance with the provisions of the 2006/42/EG guidelines is correct. As long as the machine with which the with the device should be used does not comply with the guideline, operating this product is prohibited.

Operate the unit with devices and accessories approved by SIGMATEK only.

CAUTION



Handle the device with care and do not drop or let fall.

Prevent foreign bodies and fluids from entering the device.

The device must not be opened, otherwise it could be damaged!

Manipulez l'appareil avec précaution et ne le laissez pas tomber.

Empêchez les corps étrangers et les liquides de pénétrer dans l'appareil.

L'appareil ne doit pas être ouvert, sinon il risque d'être endommagé!

In addition, the Safety Guidelines in the other sections of these instructions must be observed. These instructions are visually emphasized by symbols.

The module complies with EN 61131-2.

In combination with a machine, the machine builder must comply with EN 60204-1 standards.

For your own safety and that of others, compliance with the environmental conditions is essential.

The control cabinet must be connected to ground correctly.

To perform maintenance or repairs, disconnect the system from the power supply.

En outre, les consignes de sécurité mentionnées dans d'autres sections de ce manuel doivent être respectées. Ces directives sont indiquées avec les symboles graphiques.

Le module est conforme à la norme EN 61131-2.

En combinaison avec une machine, le constructeur de la machine doit respecter la norme EN 60204-1.

L'armoire de commande doit être raccordée correctement à la terre.

Pour l'entretien et les réparations, débranchez le système de l'alimentation.

2.4 Guidelines

The panel was constructed in compliance with European Union guidelines.

2.4.1 EU Conformity Declaration



CE Declaration of Conformity

The ETT 1234 conforms to the following European guidelines:

- 2014/35/EU Low-voltage guideline
- 2014/30/EU “Electromagnetic Compatibility” (EMC guideline)
- 2011/65/EU “Restricted use of certain hazardous substances in electrical and electronic equipment” (RoHS Guideline)

The EU Conformity Declarations are provided on the SIGMATEK website. See: Products/downloads, or use the search function and keyword “EU Declaration of Conformity”

3 Technical Data

3.1 Performance Data

Processor	EDGE2 Technology
Processor cores	2 ¹⁾
Internal cache	32-kbyte L1 Instruction Cache 32-kbyte L1 Data Cache 512-Kbyte L2 Cache
Internal program and data memory (RAM)	1-Gbyte DDR3
Internal remnant data memory	512-kbyte SRAM (battery buffered)
Internal storage device	4 GB microSD card (3D-TLC pSLC technology) ²⁾
Internal I/O	no
Interfaces	1x USB 2.0, Type A (1x back) 1x Online USB (Device) Type Mini B 2x Ethernet
Internal interfaces	1x TN color display 1x USB (touch connection) 1x Panel Interface Connector
Signal generator	no
Display	12.1" TFT color display
Resolution	WXGA 1280 x 800 pixels
Operating panel	touch screen (projective capacitive)
Status LEDs	2 (red & green)
Real-time clock	yes
Cooling	passive (fanless)

¹⁾ Attention: When programming (with LASAL) on multicore CPUs, particular focus must be placed on thread security!

²⁾ The 4 GByte microSD card is formatted to 1 GByte in order to achieve the lifetime of a standard SLC card. A format change to the full 4 GByte is not allowed and will result in a massive reduction of the microSD card's lifetime.

3.2 Electrical Requirements

Supply voltage	+18-30 V DC, typically +24 V DC UL: Class 2 or LVLC ⁽¹⁾	
Current consumption of (+24 V) power supply	typically 700 mA (without externally connected devices)	maximum 850 mA (with external devices connected)
Inrush current with 24 V/10 A fixed voltage supply	maximum 1.5 A (for 15 ms, load-dependent)	
Inrush current without current-limiting supply	maximum 65 A (for 25 μ s, load-dependent)	

⁽¹⁾ For USA and Canada:

The supply must be limited to:

- a) max. 5 A at voltages from 0-20 V DC, or
- b) 100 W at voltages from 20-60 V DC

The limiting component (e.g. transformer, power supply or fuse) must be certified by an NRTL (Nationally Recognized Testing Laboratory).

⁽¹⁾ Pour les États-Unis et le Canada:

L'alimentation doit être limitée à:

- a) max. 5 A pour des tensions de 0-20 V DC, ou
- b) 100 W pour des tensions de 20-60 V DC

Le composant imposant la limite (par exemple, transformateur, alimentation électrique ou fusible) doit être certifié par un NRTL (National Recognized Testing Laboratory, par exemple, UL).

3.3 12.1" WXGA Display

Type	12.1" TN color display
Resolution	WXGA 1280 x 800 pixels
Color depth	18-bit RGB
LCD mode	normally black ¹⁾
LCD Polarizer	transmissive ²⁾
Pixel size	0.204 x 0.204 mm
Active surface	261.12 x 163.2 mm
Backlighting	LED
Contrast	typically 1000
Brightness	typically 400 cd/m ²
Angle CR ≥ 10	left, right, top, bottom typically 89°
Life span	by compliance with the ambient conditions, the brightness of the display sinks after 50,000 operating hours to 50 % of the original brightness

¹⁾ If there is no display data, the display is black (LED backlight on)

²⁾ Display technology, with which display backlighting is used.

Due to the manufacturing process, individual pixel errors cannot be excluded to 100%.

3.4 Control Unit

Touch panel	projective capacitive touch panel
Surface	front plate: 1.8 mm glass (touch screen) in black anodized aluminum frame
Cleaning	see chapter 11



A projective capacitive touch screen is built into the panel, with which 10-finger input, Zoom and gesture functions can be implemented. Data can be input using fingers, a project capacitive touch pen as well as with thin gloves. The device must always be grounded to ensure stable function of the touch screen. The touch function may still have to be individually adapted to the respective environmental conditions.

3.5 Minimum Distance between Operating Elements for Multi-touch Applications

To guarantee smooth operation with multitouch applications, buttons and control elements that should be operated at the same time must have the minimum distance shown below (depending on the estimated touch point).

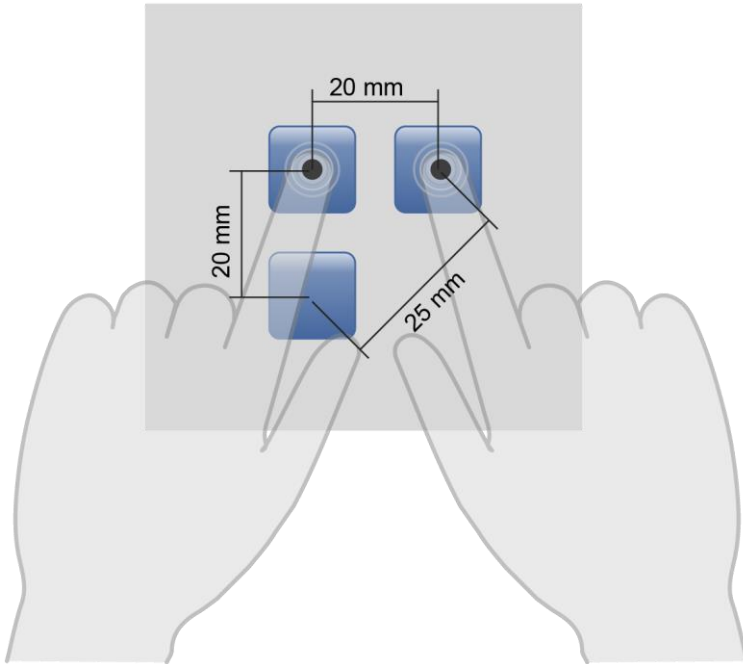

The size of the buttons and operating elements directly affect the operability of the application. Small operating elements should therefore be avoided.

3.6 Environmental Conditions

Storage temperature	-10 ... +70 °C	
Environmental temperature	0 ... +50 °C	
Humidity	10-95 %, non-condensing	
Installation altitude above sea level	0-2000 m without derating, > 2000 m with derating of the maximum environment temperature by 0.5 °C per 100 m	
Operating conditions	pollution degree 2	
EMC resistance	according to EN 61000-6-2:2007 (industrial area)	
EMC noise generation	in accordance with EN 61000-6-4 (industrial area)	
Vibration resistance	EN 60068-2-6	2-9 Hz: amplitude 3.5 mm 9-200 Hz: 1 g (9.81 m/s ²)
Shock resistance	EN 60068-2-27	15 g (147.15 m/s ²) duration 11 ms, 18 shocks
Protection type	EN 60529 protected through the housing	front: IP65 ¹⁾ cover IP20 ¹⁾

¹⁾ IP housing protection type was tested for Europe and is not part of a UL-certification for the ETTs

3.7 Miscellaneous

Article number	01-230-1234	
Hardware version	1.x	
Operating system	Salamander	
Approvals	CE, UKCA ETT 1234 consists of TP 1261 und PIM 031, both UL certified cUL _{US} (E247993)	

4 Mechanical Dimensions

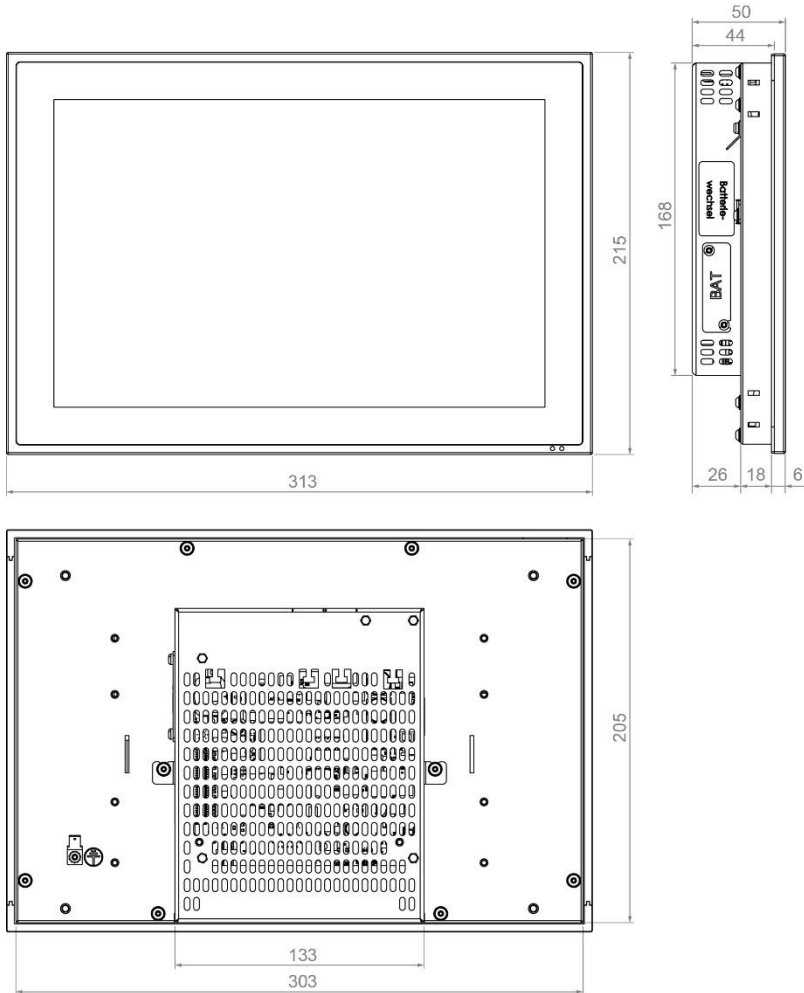

Dimensions	313 x 215 x 50 mm (W x H x D)
Material	front plate: 1.8 mm glass (touch screen) in black anodized aluminum frame housing: sheet steel
Weight	typically 2.1 kg

5 Interfaces

5.1 Bottom Connections

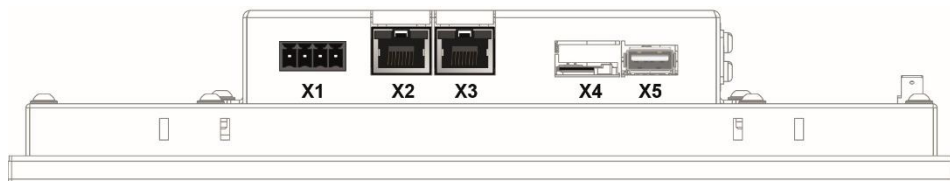

5.1.1 X1: Supply (4-pin Phoenix RM 3.5)

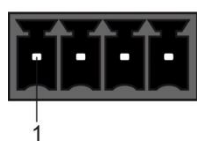

Pin	Function
1	+24 V DC
2	+24 V DC
3	GND
4	GND

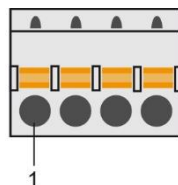

5.1.2 X2: Ethernet 2 10/100/1000 (RJ45)

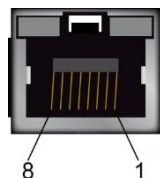

Pin	Function
1	DA+
2	DA-
3	DB+
4	DC+
5	DC-
6	DB-
7	DD+
8	DD-

5.1.3 X3: Ethernet 1 10/100 (RJ45)

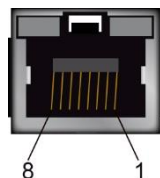

Pin	Function
1	Tx+
2	Tx-
3	Rx+
4	n.c.
5	n.c.
6	Rx-
7	n.c.
8	n.c.



Problems can arise if a control is connected to an IP network, which contains devices that are not running with a SIGMATEK operating system. With such devices, Ethernet packets could be sent to the control with such a high frequency (i.e. broadcasts), that the high interrupt load could cause a real-time runtime error or runtime error. By configuring the packet filter (Firewall or Router) accordingly, it is possible to connect a network with SIGMATEK hardware to a third party network without triggering the error mentioned above.

5.1.4 X4: microSD Card

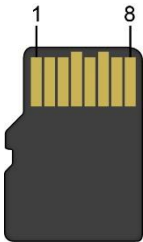

Pin	Function
1	DAT2
2	CD/DAT3
3	CMD
4	+3V3
5	CLK
6	GND
7	DAT0
8	DAT1

Size	Order Number
4 GByte	12-630-105



It is recommended that only storage media provided by SIGMATEK be used.

The number of read and write actions have a significant influence on the lifespan of the storage media.

The microSD card is not intended as an exchangeable medium and should therefore be removed from the card holder for maintenance purposed only.

5.1.5 X5: USB 2.0 (Type A)

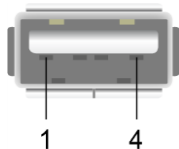

Pin	Function
1	+5 V, $I_{\text{out, max.}} = 500 \text{ mA}$
2	D-
3	D+
4	GND



It should be noted that many of the USB devices on the market do not comply with USB specifications; this can lead to device malfunctions. It is also possible that these devices will not be detected at the USB port or function correctly. It is therefore recommended that the respective USB stick be tested before actual use.

5.3 Side Connection

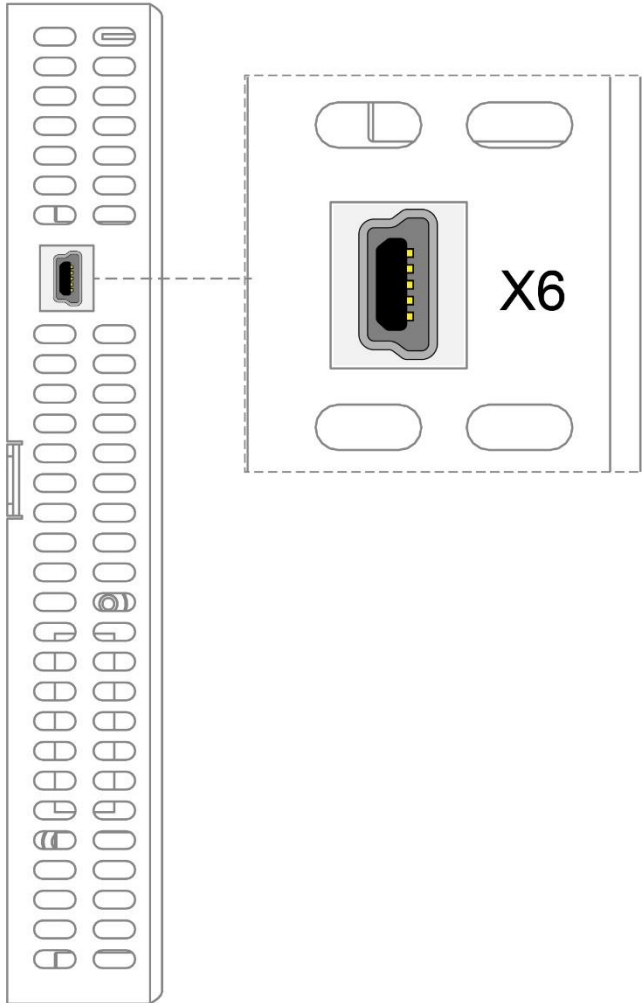

5.3.1 X6: USB 2.0 (Type Mini B)

USB device for service purposes and online USB for LasalClass

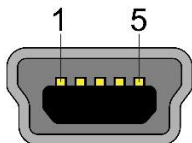

Pin	Function
1	+5 V, $I_{out\ max.} = 500\ mA$
2	D-
3	D+
4	ID
5	GND

5.4 Applicable Connectors

- X1:** 4-pin Phoenix plug with spring terminal FK-MCP 1.5/ 4-ST-3.5
- X2, X3:** 8-pin RJ45 (not included in delivery)
- X5:** USB 4-pin, Type A (downstream connector)
(not included with delivery)
- X6:** USB Type Mini B to USB Type A cable (device) (no included with delivery)

6 Cooling

The power loss in the ETTs can reach up to 21 Watts. To ensure the necessary air circulation for cooling, the following mounting instructions must be followed!

7 Mounting Instructions



During installation, caution must be taken to ensure that the aluminum front is not damaged.

The following instructions must be followed when installing the terminal:

- For installation with the screw terminals provided, it is recommended that the installation panel have a material strength of at least 1 mm and a maximum of 3 mm. The screw-in brackets can be tightened with a maximum torque of 0.2 Nm. For this purpose, a 3x 0.5 flat-tip screw driver is required.
- To avoid damage to the aluminum frame, it is important to ensure that during installation, the contact surface is clean (free of debris, uneven areas). Unevenness can lead to stress on the glass/aluminum frame or contamination from dust and water.

To dissipate waste heat from the terminal, the clearance between the back of the terminal and the back wall should be at least 100 mm.

7.1 Restricted Space Around Rear Trimming

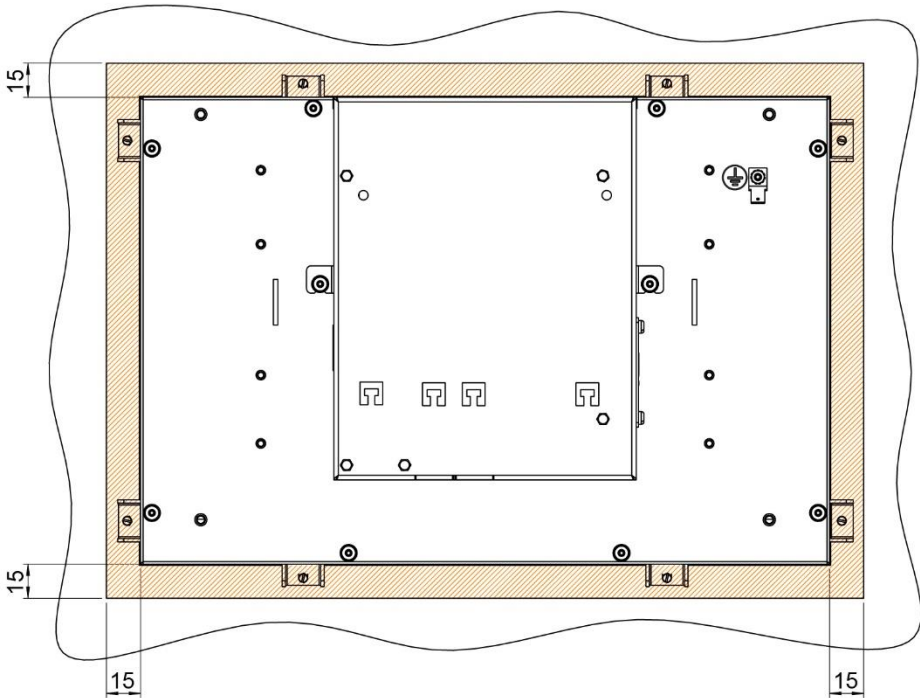

A restricted area of 15 mm around the terminal must be ensured. This is required to exchange the module when necessary, without having to remove the entire device.

7.2 Required Cutout for Mounting the Terminal

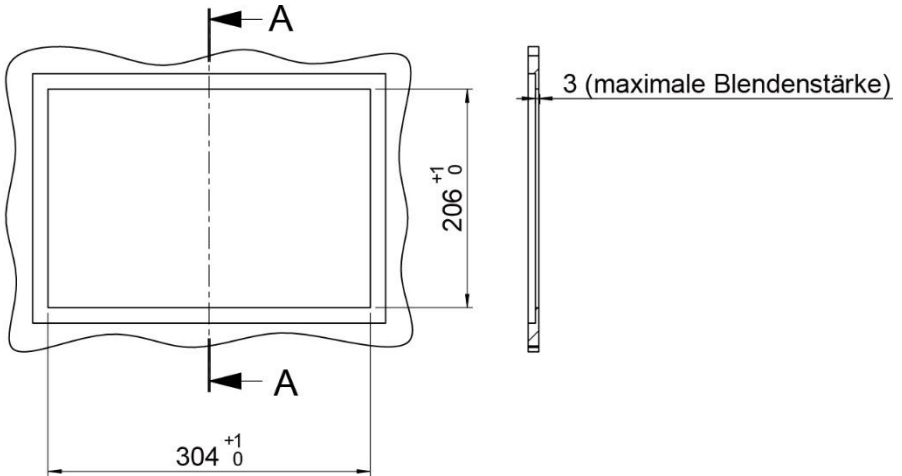

7.3 Mounting Position

Note the mounting position of 60-120°.

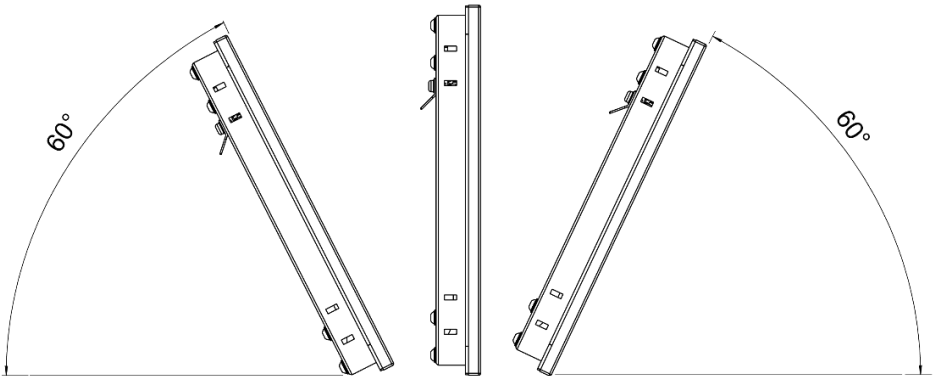

The specified installation distances may be reduced if appropriate measures and technical precautions are taken to dissipate the corresponding waste heat.

8 Wiring Guidelines

8.1 Protective Earth Connection

WARNING



The terminal must be grounded to protective earth (PE) via the M3 threaded bolts. In addition, ensure that when installing into the control cabinet, a large grounding surface is provided. It is essential to establish a low-Ohm connection to ground to ensure error-free function. The ground connection must be made with the maximum wire cross-section and largest (electrical) surface possible. The cable length of the ground connection must also be kept as short as possible.

La borne doit être reliée à la terre de protection (PE) par les boulons filetés M3. De plus, lors de l'installation dans l'armoire électrique, veillez à ce qu'une grande surface de mise à la terre soit prévue. Il est essentiel d'établir une connexion de faible ohms à la terre pour assurer un fonctionnement sans erreur. La mise à la terre doit être réalisée avec la section de fil maximale et la plus grande surface (électrique) possible. La longueur du câble de mise à la terre doit également être aussi courte que possible.

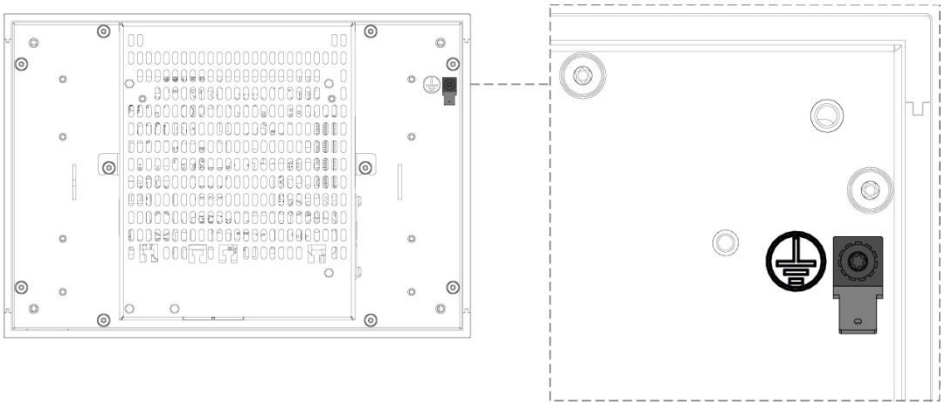

8.2 Shielding

For Ethernet, **CAT5e-compliant** cables are recommended. The cable shielding is connected to ground via the RJ45 connector. Noise signals can then be prevented from reaching the electronics and affecting the function.

8.3 ESD Protection



Typically, USB devices (keyboard, mouse...) are not equipped with shielded cables. These devices are disrupted by electrostatic discharge and in some instances, no longer function.

Généralement, les périphériques USB (clavier, souris...) ne sont pas équipés de câbles blindés. Ces dispositifs sont perturbés par des décharges électrostatiques et, dans certains cas, ne fonctionnent plus.

Before any device is connected to, or disconnected from the terminal, the potential should be equalized (by touching the control cabinet or ground terminal). Electrostatic loads (through clothing and shoes) can be thereby dissipated.

Avant de connecter ou de déconnecter un appareil à la borne, le potentiel doit être égalisé (en touchant l'armoire électrique ou la borne de terre). Les charges électrostatiques (à travers les vêtements et les chaussures) peuvent ainsi être éliminées.

8.4 USB Interface Connections

The terminal has a USB interface. In LASAL, this interface can be used for various USB devices (keyboard, mouse, storage media, hubs, etc.). Using a hub, several USB devices can be connected that are then fully functional in LASAL.

9 Status LEDs

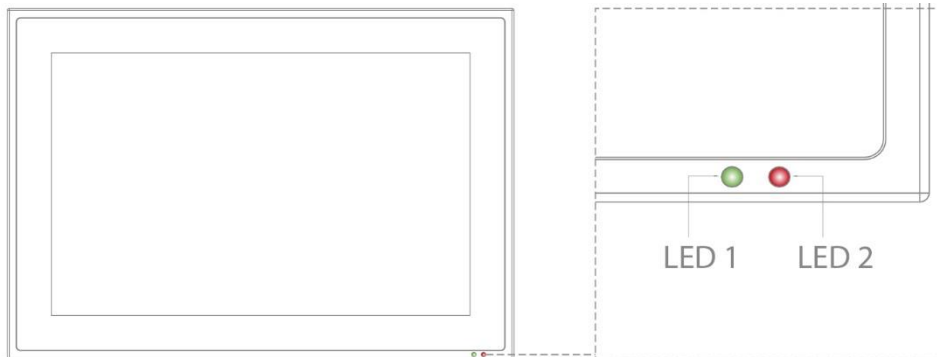

LED	Color	Definition
1	green	DCOK
2	red	Error

The status LEDs can be controlled via the application. With standard settings within an application or after starting the operating system, the LEDs respond as follows:

Turning on the supply	DCOK lights green
In the CLI, while processing the autoexec.lsl until the application is running	DCOK lights green Error blinks red
While the running the application ¹⁾	DCOK lights green Error does not light

¹⁾The LEDs can be programmed via the application.

10 Display „Burn-In“ Effect

The “Burn-In” effect describes a pattern burned into the display after displaying the same contents over a longer period of time (e.g. a single screen).

This effect is also described mostly as “image sticking”, “memory effect/sticking” or “ghost image”. Here, a distinction is made between a temporary and permanent effect. While the temporary effect fades after the screen has been turned off for some time or when dynamic content is displayed, damage from the permanent effect is irreversible.

This effect can have the following causes:

- Operation without a screen saver
- The same contents displayed over a longer time period (e.g. a single screen)
- Operation at high ambient temperatures
- Operation above specifications

The effect can be avoided/reduced by the following actions:

- Using a screen saver
- Deactivating the display when not in use
- Continuously changing screen content (e.g. video)

11 Cleaning the Touch Screen

WARNING



Before cleaning the touch screen, it must be deactivated in order to prevent triggering functions or commands unintentionally; either by turning of the terminal or disabling the touch screen via the application!

Avant de nettoyer l'écran tactile, il faut le désactiver afin d'éviter tout déclenchement involontaire de fonctions ou de commandes ; soit en tournant le terminal, soit en désactivant l'écran tactile via l'application !

The touch screen can only be cleaned with a soft, damp cloth. To dampen the cloth, we recommend a mild cleaning solution such as antistatic foam cleaner. To avoid fluids/cleaning solutions from getting into the housing, the device must not be sprayed directly. To clean, no erosive cleaning solutions, chemicals, abrasive cleansers or hard objects that can scratch or damage the touch screen may be used. The use of steam jets or compressed air is prohibited.

DANGER



If the device is contaminated with toxic or erosive chemicals, it must be carefully cleaned as quickly as possible to prevent personal injury and machine damage!

Si l'appareil est contaminé par des produits chimiques toxiques ou érosifs, il doit être nettoyé avec soin le plus rapidement possible afin d'éviter des blessures corporelles et des dommages matériels!



To ensure the optimal function of the panel, the touch screen should be cleaned in regular intervals!

12 Buffer Battery

The exchangeable buffer battery ensures that the clock time (RTC) and relevant system information are preserved in the absence of a supply voltage. A lithium battery is installed at the manufacturer.

The lifespan of the battery is at least five years if the device was mainly in operation after the initial start-up (supply voltage applied)

To achieve this lifespan, the ETT should not be stored longer than one year after delivery.

We recommend replacing the battery annually.



If the Buffer Battery is empty, it should be replaced by an identical Buffer Battery.

Use only Buffer Battery from RENATA with the number: **CR2032**

The SIGMATEK order number can be found below in the chapter Accessories.

If the battery voltage is located between both thresholds of the monitoring switch, the battery can be detected as good during operation, but as low after turning off and on. In this case, we recommend exchanging the battery.

12.1 Exchanging the Battery

12.1.1 Without Supply

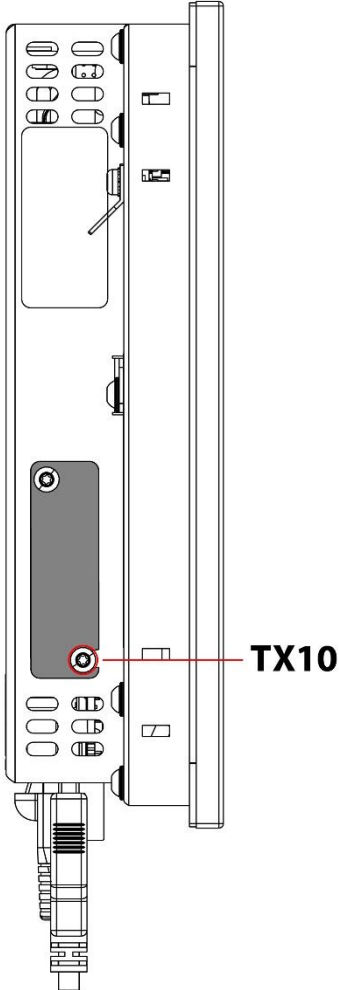

1. Turn off the device supply. After turning off the supply, three minutes of buffering is provided to replace battery.
 - i. We recommend to first save the SRAM data to the microSD card with the CLI command `SRAM Save`, in case there are complications during the battery exchange.
2. Loosen the locking screws in the battery cover with a TX10 Torx screw driver.

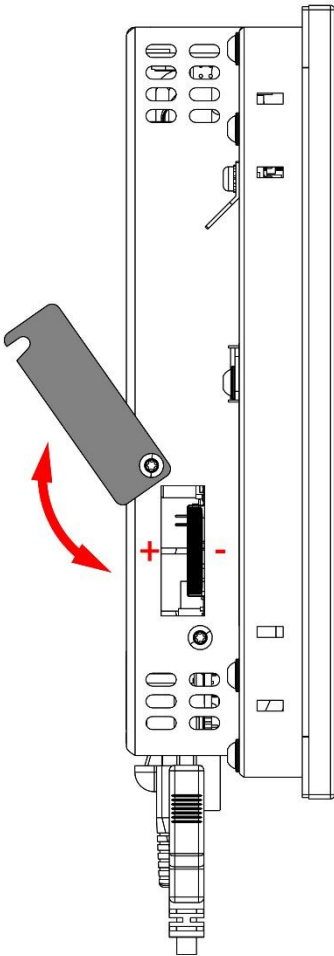

3. Rotate the cover in the direction of the arrow shown below.
4. Using the strap, remove the battery from the holder.
5. Install the new battery with the correct polarity.
6. Close the battery cover.
7. Tighten the fastening screws.
 - i. The previously saved SRAM data can now be reloaded from the microSD card with the SRAM Load command.

12.1.2 With Active Supply

If the battery is exchanged when an active supply is connected, there is no time limit. Preferably however, save the SRAM data on the microSD card in case the power supply is interrupted during the exchange.

CAUTION

Avoid contact with the electronics via conductive objects, such as tools for example.

Eviter tout contact avec l'électronique par l'intermédiaire d'objets conducteurs, tels que des outils par exemple.

1. Supply the device with +24 V for at least 5 seconds.
2. Follow the steps in chapter 12.1.1 starting with step 2.

13 Maintenance



During maintenance as well as servicing, the safety instructions from chapter 2 must be observed.

13.1 Maintenance

This product was constructed for low-maintenance operation.

13.1.1 Calibrating the Touch Screen

The touch screen is calibrated at the factory. You should therefore only recalibrate the touch screen when press-point changes are noticed.

The calibration can be run either with the following CLI command or via the application (as long as it is provided by the application engineer).

```
calib
```

13.2 Repair



When sent for repair, the panel should be transported in the original packaging if possible. Otherwise, packaging should be selected that sufficiently protects the product from external mechanical influences. Such as cardboard filled with air cushioning.

In the event of a defect/repair, send the panel with a detailed error description to the address listed at the beginning of this document.

13.3 Position Series Label Sub Device

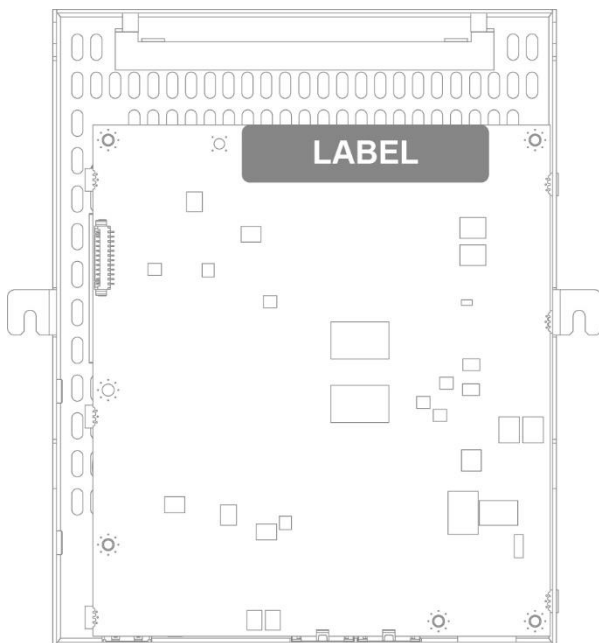

14 Process Diagram

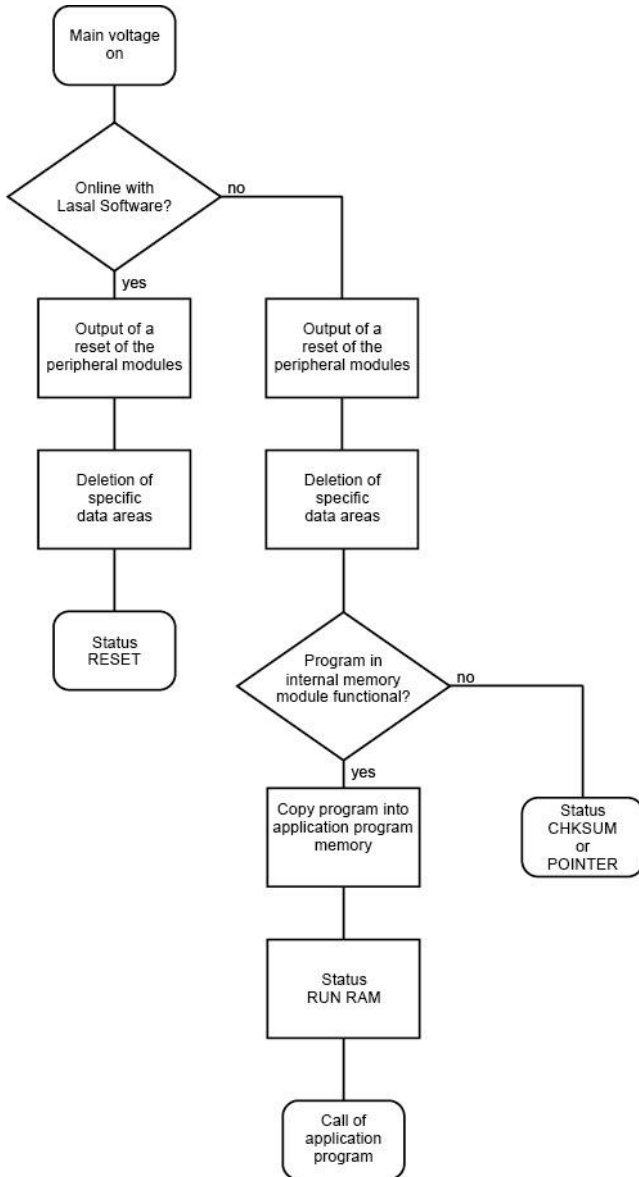

15 Status and Error Messages

Status and error messages are displayed in the LASAL CLASS software status test. POINTER or CHKSUM messages are shown on the terminal screen.

Number	Message	Definition	Cause/solution
00	RUN RAM	The user program is currently running in RAM. The display is not affected.	Info
01	RUN ROM	The user program stored in the program memory module was loaded into the RAM and is currently running. The display is not affected.	Info
02	RUNTIME	The total time for all cyclic objects exceeds the maximum time; the time can be configured using 2 system variables: - Runtime: Remaining time - SWRuntime: Preset value for runtime counter	Optimize the application's cyclic task. Use higher capacity CPU. Configure preset value
03	POINTER	Incorrect program pointers were detected before running the user program	Possible Causes: - The program memory module is missing, not programmed or defective. - The program in the user program memory (RAM) is not executable. - The buffer battery has failed. - The user program has overwritten a software error. Solution: - Reprogram the memory module, if the error reoccurs exchange the module. - Exchange the buffering battery - Correct programming error
04	CHKSUM	An invalid checksum was detected before running the user program.	Cause/solution: s. POINTER

05	WATCHDOG	The program was interrupted via the watchdog logic.	<p>Possible Causes:</p> <ul style="list-style-type: none"> - User program interrupts blocked over a longer period of time (STI command forgotten). - Programming error in a hardware interrupt. - INB, OUTB, INW, OUTW instructions used incorrectly. - The processor is defective. <p>Solution:</p> <ul style="list-style-type: none"> - Correct programming error. - Exchange CPU
06	GENERAL ERROR	<p>General error</p> <p>An error has occurred while stopping the application over the online interface.</p>	This error occurs only during the development of the operating system.
07	PROM DEFECT	An error has occurred while programming the memory module.	<p>Causes:</p> <ul style="list-style-type: none"> - The program memory module is defective. - The user program is too large. - The program memory module is missing. <p>Solution:</p> <ul style="list-style-type: none"> - Exchange the program memory module.
08	RESET	<p>The CPU has received the reset signal and is waiting for further instructions.</p> <p>The user program is not processed.</p>	Info
09	WD DEFECT	<p>The hardware monitoring circuit (watchdog logic) is defective.</p> <p>After power-up, the CPU checks the watchdog logic function. If an error occurs during this test, the CPU deliberately enters an infinite loop from which no further instructions are accepted.</p>	<p>Solution:</p> <ul style="list-style-type: none"> - Exchange CPU
10	STOP	The program was stopped by the programming system.	
11	PROG BUSY	Reserved	
12	PROGRAM LENGTH	Reserved	
13	PROG END	A memory module was successfully programmed.	Info
14	PROG MEMO	The CPU is currently programming the memory module.	Info

15	STOP BRKPT	The CPU was stopped by a breakpoint in the program.	Info
16	CPU STOP	The CPU was stopped by the programming software.	Info
17	INT ERROR	The CPU has triggered a false interrupt and stopped the user program or has encountered an unknown instruction while running the program.	Causes: <ul style="list-style-type: none"> - A nonexistent operating system was used. - Stack error (uneven number of PUSH and POP instructions). - The user program was interrupted by a software error. Solution: <ul style="list-style-type: none"> - Correct programming error.
18	SINGLE STEP	The CPU is in single step mode and is waiting for further instructions.	Info
19	READY	A module or project has been sent to the CPU and it is ready to run the program.	Info
20	LOAD	The program is stopped and the CPU is currently receiving a new module or project.	Info
21	INVALID MODULE	The CPU has received a module that does not belong to the project.	Solution: <ul style="list-style-type: none"> - Recompile and download the entire project
22	MEMORY FULL	The operating system memory (heap) is too small. No memory could be reserved while calling an internal function or an interface function is called from the application.	Causes: <ul style="list-style-type: none"> - Memory is only allocated but not released. Solution: <ul style="list-style-type: none"> - Clear memory
23	NOT LINKED	When starting the CPU, a missing module or a module that does not belong to the project was detected.	Solution: <ul style="list-style-type: none"> - Recompile and download the entire project
24	DIV BY 0	A division error has occurred.	Possible Causes: <ul style="list-style-type: none"> - Division by 0. - The result of a division does not fit in the result register. Solution: <ul style="list-style-type: none"> - Correct programming error.
25	DIAS ERROR	While accessing a DIAS module, an error has occurred.	Hardware problem
26	WAIT	The CPU is busy.	Info

27	OP PROG	The operating system is currently being reprogrammed.	Info
28	OP INSTALLED	The operating system has been reinstalled.	Info
29	OS TOO LONG	The operating system cannot be loaded; too little memory.	Restart, report error to SIGMATEK.
30	NO OPERATING SYSTEM	Boot loader message. No operating system found in RAM.	Restart, report error to SIGMATEK.
31	SEARCH FOR OS	The boot loader is searching for the operating system in RAM.	Restart, report error to SIGMATEK.
32	NO DEVICE	Reserved	
33	UNUSED CODE	Reserved	
34	MEM ERROR	The operating system loaded does not match the hardware configuration.	Solution: - Use the correct operating system version
35	MAX IO	Reserved	
36	MODULE LOAD ERROR	The LASAL Module or project cannot be loaded.	Solution: - Recompile and download the entire project
37	BOOTIMAGE FAILURE	A general error has occurred while loading the operating system.	Contact SIGMATEK
38	APPLMEM ERROR	An error has occurred in the application memory (user heap).	Solution: - Correct allocated memory access error
39	OFFLINE	This error does not occur in the control.	This error code is used in the programming system to show that there is no connection to the control.
40	APPL LOAD	Reserved	
41	APPL SAVE	reserved	
44	VARAN MANAGER ERROR	An error number was entered in the VARAN manager and stopped the program.	Solution: - Read LogFile
45	VARAN ERROR	A required VARAN client was disconnected or a communication error has occurred.	Solution: - Read LogFile - Error Tree

46	APPL-LOAD-ERROR	An error has occurred while loading the application.	Cause: - Application was deleted. Solution: - Reload the application into the control.
47	APPL-SAVE-ERROR	An error has occurred while attempting to save the application.	
50	ACCESS-EXCEPTION-ERROR	Read or write access of a restricted memory area. (I.e. writing to the NULL pointer).	Solution: - Correct application errors
51	BOUND EXCEEDED	An exception error has occurred while accessing arrays. The memory area was overwritten by accessing an invalid element.	Solution: - Correct application errors
52	PRIVILEGED INSTRUCTION	An unauthorized instruction for the current CPU level was given. For example, setting the segment register.	Cause: - The application has overwritten the application program code. Solution: - Correct application errors
53	FLOATING POINT ERROR	An error has occurred during a floating-point operation.	
60	DIAS-RISC-ERROR	Error from the Intelligent DIAS Master.	Restart, report error to SIGMATEK.
64	INTERNAL ERROR	An internal error has occurred, all applications are stopped.	Restart, report error to SIGMATEK.
65	FILE ERROR	An error has occurred during a file operation.	
66	DEBUG ASSERTION FAILED	Internal error	Restart, report error to SIGMATEK.
67	REALTIME RUNTIME	The total duration of all real-time objects exceeds the maximum time; the time cannot be configured. 2 ms for 386 CPUs 1 ms for all other CPUs	Solution: - Optimize the application's real-time task (RtWork). - Reduce the clock time for the real-time task of all objects. - Correct application errors - CPU is overloaded in real-time => use a higher capacity CPU.
68	BACKGROUND RUNTIME	The total time for all background objects exceeds the maximum time; the time can be configured using 2 system variables: -BTRuntime: Remaining time -SWBTRuntime: Preset value for runtime counter	Solution: - Optimize the application's background task (background) - Use higher capacity CPU - Set SWBTRuntime correctly

70	C-DIAS ERROR	A connection error with a C-DIAS module has occurred.	<p>Cause:</p> <ul style="list-style-type: none"> - The cause of the error is documented in the log file <p>Solution:</p> <ul style="list-style-type: none"> - This depends on the cause
72	S-DIAS ERROR	A connection error with an S-DIAS module has occurred.	<p>Possible Causes:</p> <ul style="list-style-type: none"> - Real network does not match the project - S-DIAS client is defective <p>Solution:</p> <ul style="list-style-type: none"> - Analyze log file
75	SRAM ERROR	An error occurred while initializing, reading or writing SRAM data.	<p>Possible Causes:</p> <ul style="list-style-type: none"> - SRAM configured incorrectly - Battery for powering the internal program memory is empty <p>Solution:</p> <ul style="list-style-type: none"> - Analyze log file (Event00.log, Event19.log) - Check configuration - Exchange battery for powering the internal program memory
95	USER DEFINED 0	User-definable code.	
96	USER DEFINED 1	User-definable code.	
97	USER DEFINED 2	User-definable code.	
98	USER DEFINED 3	User-definable code.	
99	USER DEFINED 4	User-definable code.	
100	C_INIT	Initialization start; the configuration is run.	
101	C_RUNRAM	The LASAL project was successfully started from RAM.	
102	C_RUNROM	The LASAL project was successfully started from ROM.	
103	C_RUNTIME		
104	C_READY	The CPU is ready for operation.	
105	C_OK	The CPU is ready for operation.	

106	C_UNKNOWN_CID	An unknown object from a stand-alone or embedded object, or an unknown base class was detected.	
107	C_UNKNOWN_CONSTR	The operating system class cannot be created; the operating system is probably wrong.	
108	C_UNKNOWN_OBJECT	Indicates an unknown object in an interpreter program; more the one DCC080 object.	
109	C_UNKNOWN_CHNL	The hardware module number is greater than 60.	
110	C_WRONG_CONNECT	No connection to the required channels.	
111	C_WRONG_ATTR	Wrong server attributes.	
112	C_SYNTAX_ERROR	Non-specific error. Recompile and download all project sections.	
113	C_NO_FILE_OPEN	An attempt was made to open an unknown table.	
114	C_OUTOF_NEAR	Memory allocation failed	
115	C_OUT OF_FAR	Memory allocation failed	
116	C_INCOMAPTIBLE	An object with the same name already exists but has a different class.	
117	C_COMPATIBLE	An object with the same name and class exists but must be updated.	
224	LINKING	The application is currently linking.	
225	LINKING ERROR	An error has occurred while linking.	
226	LINKING DONE	Linking is complete.	
230	OP BURN	The operating system is currently being burned into the Flash memory.	
231	OP BURN FAIL	An error has occurred while burning the operating system.	
232	OP INSTALL	The operating system is currently being installed.	
240	USV-WAIT	The power supply was disconnected; the UPS is active. The system is shutdown.	
241	REBOOT	The operating system is restarted.	
242	LSL SAVE		
243	LSL LOAD		

252	CONTINUE		
253	PRERUN	The application is started.	
254	PRERESET	The application is ended.	
255	CONNECTION BREAK		

16 Modularity

Through its modular construction, the device is prepared for a simple exchange of components. This makes it possible in the future, to vary the touch panel (TP) or panel interface module (PIM), and adapt to actual system requirements.

16.1 Mounting



The base station is a sensitive electronic device. When mounting, as well as dismantling, note that you come into contact with ESD-sensitive areas of the device.

The applicable ESD measures must be taken!

La station de base est un appareil électronique sensible. Lors de l'ouverture de la base et du remplacement de la carte microSD, notez que vous êtes en contact avec des zones sensibles ESD de l'appareil.

Les mesures d'ESD applicables doivent être prises !

CAUTION



The device is not Hot-Plug capable and can be damaged when the supply is not disconnected before inserting or removing the PIM.

Always disconnect the supply before inserting or removing.

L'appareil n'est pas compatible Hot-Plug et peut être endommagé si l'alimentation n'est pas débranchée avant d'insérer ou de retirer le PIM.

Toujours débrancher l'alimentation avant de l'insérer ou de la débrancher.

To mount PIM with TP, follow the steps below:

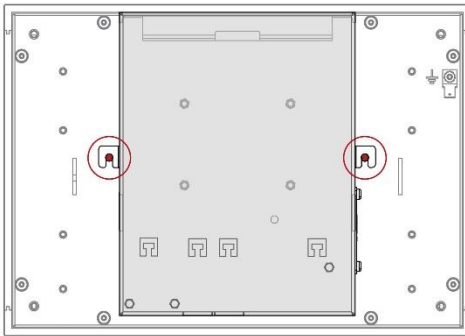
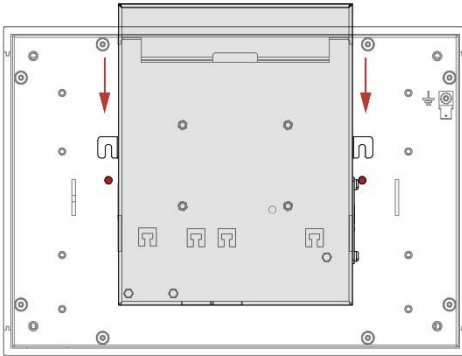

1. Ensure that an ESD-compliant working method is followed (ESD arm-band, ESD clothing).
2. Disconnect the PIM as well as the TP from voltage.
3. Place the TP flat on its back.
4. Place the PIM onto the TP so that the locking clamps of the PIM are securely held in the notches of the TP.
5. Slide the PIM in the direction of the arrows shown.
6. When locking, a “click” can be clearly heard and the short side of the PIM closes evenly with the housing of the TP.
7. Secure the PIM to the TP using the previously loosened screws and a TX10 Torx screwdriver with a torque of 0.7.

16.2 Disassembly

To separate the two components, follow the steps in chapter 16.1 in reverse order.

17 Accessories



Use only batteries from RENATA with the number: CR2032

17.1 Buffer Battery

Label	Order Number
Renata CR2032 (225 mAh)	01-690-028

18 Transport/Storage



This device contains sensitive electronics. During transport and storage, high mechanical stress must therefore be avoided.

For storage and transport, the same values for humidity and vibration as for operation must be maintained!

CAUTION



During transport, temperature and humidity fluctuations may occur. Ensure that no moisture condenses in or on the device.

Pendant le transport, des fluctuations de température et d'humidité peuvent survenir. Veillez à ce qu'il n'y ait pas de condensation d'humidité dans ou sur l'appareil.

19 Disposal



When disposing of the panel, the national electronic scrap regulation must be observed.

The panel cannot be discarded with domestic waste.



Documentation Changes

Change date	Affected page(s)	Chapter	Note
16.07.2019	12	3.3 Display	Color depth changed from 24 to 18 bits
04.09.2019		3 Technical Data	UL certification
20.08.2020	35	13.3 Position Series Label Sub Device	Chapter added
11.11.2020	11 16	3.1 Performance Data 4 Mechanical Dimensions	Footnote cores (programming) added More details
06.12.2022	15	3.7 Miscellaneous	UKCA conformity
13.03.2024	11 17	3.1 Performance Data 5 Connector Layout	microSD card updated
04.11.2024	47	17.1 Buffer Battery	Battery data changed